

RECESSED FIXTURE INSTALLATION DIAGNOSIS

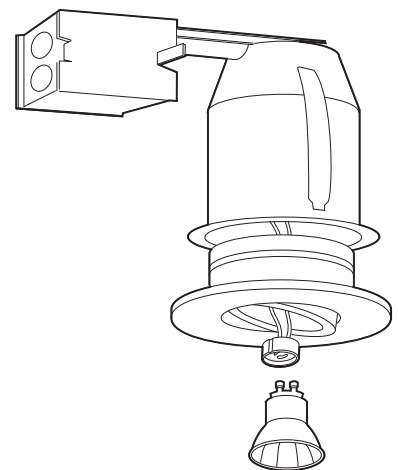

**For advices on installation please refer to our videos on our website.

Before installing recessed fixtures it is important to identify in what type of ceiling they will be installed.















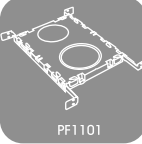

The type of ceiling determinates the level of complexity for installation and which accessories will be required.

Note : BAZZ recessed fixtures can only be installed with BAZZ accessories.

CAUTION ! We recommend using the services of a qualified electrician for installation. Wiring has to be done and secured by an electrician. Please refer to the Electrical code of your region.

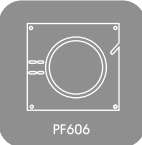
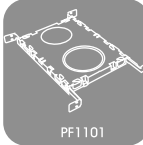
01

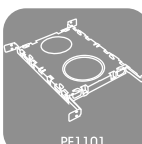
CEILING INSTALLATION: CEILING IS...?

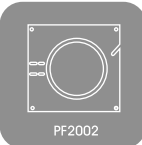
CEILING TYPE	REQUIRED ACCESSORIES	INSTALLATION
A. Installed ceiling / Existing (Retrofit Installation)		
1. Non-insulated ceiling 	 <p>No accessories required</p> <p>Only the recessed fixture is inserted in the ceiling. BAZZ recessed fixtures are complete and ready to be installed. Packaging includes: installation clips, bulb housing, junction box and decorative trim.</p>	<p>The fixture is inserted in the ceiling hole opening and fastened with 2 screws. For the high hole diameter, refer to the template included with packaging.</p>
2. Insulated ceiling 	 <p>BT1200</p> <p>Mandatory except for LED or CFL recessed fixtures approved for insulated ceiling as is, no insulated ceiling box required.</p>  <p>VAP101</p> <p>Recommended if ceiling is located under an attic space (exterior ceiling).</p>	<p>The insulated ceiling box separates insulation material from the fixture, indicates where to install the fixtures and where the ceiling openings have to be done once the gypsum is installed.</p> <p>The vapor barrier is recommended to avoid risks of condensation and waste of energy.</p> <p>For installation, you need to have access to the ceiling space to install 1) the insulated ceiling box by fastening the bar hangers to the structure 2) the vapor-barrier above the insulated ceiling box.</p>
B. Not installed ceiling / Non-existing (New construction or renovation)		
1. Non-insulated ceiling 	 <p>PF1101</p>	<p>We recommend using the PF1101 plaster frame to indicate where to install the fixtures and where the ceiling openings have to be done once the gypsum is installed.</p> <p>For installation, lateral bar hangers are fastened to the structure.</p>
2. Insulated ceiling 	 <p>BT1200</p> <p>Mandatory except for LED or CFL recessed fixtures approved for insulated ceiling as is, no insulated ceiling box required.</p>  <p>VAP101</p> <p>Recommended if ceiling is located under an attic space (exterior ceiling).</p>	<p>The insulated ceiling box separates insulation material from the fixture, indicates where to install the fixtures and where the ceiling openings have to be done once the gypsum is installed.</p> <p>The vapor barrier is recommended to avoid risks of condensation and waste of energy.</p> <p>For installation, you need to have access to the ceiling space to install 1) the insulated ceiling box by fastening the bar hangers to the structure 2) the vapor-barrier above the insulated ceiling box.</p>
C. Hanging ceiling or exterior soffit ceiling		
1. Rigid hanging ceiling 	 <p>PF2002</p>  <p>PF606</p> <p>For series 606 only.</p>  <p>PF1101</p> <p>For recessed fixtures of 3 3/8 inches diameter only.</p>	<p>The plaster frame is inserted in between the ceiling and the fixture to fastened the installation without damaging the ceiling.</p> <p>For PF2002/PF606 installation, cut the frame where indicated and insert it through the ceiling hole opening.</p> <p>For PF1101 installation, lateral bar hangers are fastened to the structure.</p>
2. Flexible hanging ceiling 	 <p>PF1101</p>	<p>The plaster frame is inserted in between the ceiling and the fixture to fastened the installation without damaging the ceiling.</p> <p>For installation, lateral bar hangers are fastened to the structure.</p>
3. Soffit ceiling 	 <p>PF2002</p>	<p>The plaster frame is inserted in between the ceiling and the fixture to fastened the installation without damaging the ceiling.</p> <p>For installation, cut the frame where indicated and insert it through the ceiling hole opening..</p> <p>With exterior soffit ceiling, only series 200 and 400 can be installed.</p>

02

WHAT IS THE CLEARANCE ABOVE THE CEILING ?

IF INSULATED

CAUTION! In an insulated ceiling a **minimum height of 7 ½ inches** is required to install the mandatory insulated ceiling box (BT1200). This excludes additional space required for insulation material. Please refer to the Electrical code of your region.

If the height is under 7 ½ inches, LED or CFL recessed fixtures approved for insulated ceiling as is, with no insulated ceiling box required can be installed. Please refer to product specifications.

IF NON-INSULATED

SERIES	4 ½" ≤ H ≤ 5	5 ≤ H ≤ 6	6 ≤ H ≤ 7	7 ≤ H ≤ 8	8 ≤ H ≤ 9
100	•	•	•	•	•
200	•	•	•	•	•
300 - 300 PRO	•	•	•	•	•
303	•	•	•	•	•
303 LED	•	•	•	•	•
400		•	•	•	•
500	•	•	•	•	•
606					•
800-803			•	•	•
900			•	•	•
JIB 3 3/8	•	•	•	•	•
JIB 3 7/8		•	•	•	•
CFL 100		•	•	•	•
CFL 400		•	•	•	•
CUBE		•	•	•	•

03

HOW THICK IS THE CEILING ?

SERIES	$0'' \leq \acute{E} \leq 1/4''$	$1/4'' \leq \acute{E} \leq 1/2''$	$1/2'' \leq \acute{E} \leq 3/4''$	$3/4'' \leq \acute{E} \leq 1''$	$\acute{E} > 1''$
100			•	•	
200	•	•	•	•	
300 - 300 PRO			•	•	
303			•	•	
303 LED			•	•	
400	•	•	•	•	
500			•	•	
606			•	•	
700-703			•	•	•
800-803			•	•	
900			•	•	•
JIB 3 3/8		•	•		
JIB 3 7/8		•	•		
CFL 100			•	•	
CFL 400			•	•	
CUBE			•	•	